

Led Pool Light



LED Pool Light

- PAR56 Stainless Steel Pool Light
- PAR56 Plastic Pool Light
- Cree COB Pool Light
- Vinyl Pool Pool Light
- Wall Mounted Pool Light

Applications

Fresh or chlorine water
Sea or salt water swimming pool
Exterior structure
Fountain Pool
Spa space

GNH-P56B-18*3W(RGB 3 IN 1 LED)



Power:25W
Voltage:AC/DC12V
Color:White,Red, Green, Blue, Yellow. RGB
LED Type:High Power
Size:Φ 177mm x H106mm
Material:316 Stainless Steel + Transparent PC cover
IP Rate:IP68
Beam Angle:30°/45°/60°
Packing:20PCS/Carton

GNH-P56B-12*3W(RGB 3 IN 1 LED)



Power:21W
Voltage:AC/DC12V
Color:White,Red, Green, Blue, Yellow. RGB
LED Type:High Power
Size:Φ 177mm x H106mm
Material:316 Stainless Steel + Transparent PC cover
IP Rate:IP68
Beam Angle:30°/45°/60°
Packing:20PCS/Carton

GNH-P56B-18*1W



Power:18W
Voltage:AC/DC12V
Color:White,Red, Green, Blue, Yellow. RGB
LED Type:High Power
Size:Φ 177mm x H106mm
Material:316 Stainless Steel + Transparent PC cover
IP Rate:IP68
Beam Angle:30°/45°/60°
Packing:20PCS/Carton

GNH-P56B-S5*105



Power:19W
Voltage:AC/DC12V
Color:White,Red, Green, Blue, Yellow. RGB
LED Type:105PCS * SMD5050 LED Chip
Size:Φ 177mm x H106mm
Material:316 Stainless Steel + Transparent PC cover
IP Rate:IP68
Beam Angle:120°
Packing:20PCS/Carton

GNH-P56B-S3*315

Power:19W
 Voltage:AC/DC12V
 Color:White,Red, Green, Blue, Yellow. RGB
 LED Type:315PCS * DIP F5/SMD3528 LED chip
 Size:Φ177mm x H106mm
 Material:316 Stainless Steel + Transparent PC cover
 IP Rate:IP68
 Beam Angle:25° /120°
 Packing:20PCS/Carton

GNH-P56B-S3*252

Power:15W
 Voltage:AC/DC12V
 Color:White,Red, Green, Blue, Yellow. RGB
 LED Type:252PCS * DIP F5/SMD3528 LED Chip
 Size:Φ177mm x H106mm
 Material:316 Stainless Steel + Transparent PC cover
 IP Rate:IP68
 Beam Angle:25° /120°
 Packing:20PCS/Carton

GNH-P56B-S5*72

Power:36W
 Voltage:AC/DC12V
 Color:White,Red, Green, Blue, Yellow.
 LED Type:72 pc SMD5730 LED Chip
 Size:Φ177mm x H106mm
 Material:316 Stainless Steel + Transparent PC cover
 IP Rate:IP68
 Beam Angle:120°
 Packing:20PCS/Carton

GNH-P56B-S5*48

Power:26W
 Voltage:AC/DC12V
 Color:White,Red, Green, Blue, Yellow.
 LED Type:48 pcs SMD5730 LED Chip
 Size:Φ177mm x H106mm
 Material:316 Stainless Steel + Transparent PC cover
 IP Rate:IP68
 Beam Angle:120°
 Packing:20PCS/Carton

GNH-P56B-S5*24

Power:13W
 Voltage:AC/DC12V
 Color:White,Red, Green, Blue, Yellow. RGB
 LED Type:24 pcs SMD5730 LED Chip
 Size:Φ177mm x H106mm
 Material:316 Stainless Steel + Transparent PC cover
 IP Rate:IP68
 Beam Angle:120°
 Packing:20PCS/Carton

GNH-P56B-COB35W

Power:36W
 Voltage:AC/DC12V
 Color:White,Red, Green, Blue, Yellow. RGB
 LED Type:1 pc 35W Bridgelux COB LED
 Size:Φ177mm x H106mm
 Material:316 Stainless Steel + Transparent PC cover
 IP Rate:IP68
 Beam Angle:120°
 Packing:20PCS/Carton

GNH-P56B-COB30W

Power:33W
 Voltage:AC/DC12V
 Color:White,Red, Green, Blue, Yellow. RGB
 LED Type:1 pc 30W Bridgelux COB LED
 Size:Φ177mm x H106mm
 Material:316 Stainless Steel + Transparent PC cover
 IP Rate:IP68
 Beam Angle:120°
 Packing:20PCS/Carton

GNH-P56B-COB25W

Power:26W
 Voltage:AC/DC12V
 Color:White,Red, Green, Blue, Yellow. RGB
 LED Type:1 pc 25W Bridgelux COB LED
 Size:Φ177mm x H106mm
 Material:316 Stainless Steel + Transparent PC cover
 IP Rate:IP68
 Beam Angle:120°
 Packing:20PCS/Carton

GNH-P56B-COB20W

Power:20W
 Voltage:AC/DC12V
 Color:White,Red, Green, Blue, Yellow.
 LED Type:1 pc 20W Bridgelux COB LED
 Size:Φ177mm x H106mm
 Material:316 Stainless Steel + Transparent PC cover
 IP Rate:IP68
 Beam Angle:120°
 Packing:20PCS/Carton

GNH-P56A-18*3W(RGB 3 IN 1 LED)

Power:27 W
 Voltage:AC/DC12V
 Color: RGB
 LED Type:High Power
 Size:Φ177mm x H105mm
 Material:Plastic + Transparent PC cover
 IP Rate:IP68
 Beam Angle:25°/30°/45°/60°
 Packing:20PCS/Carton

GNH-P56A-18*1W-H

Power:20W
 Voltage:AC/DC12V
 Color:White,Red, Green, Blue, Yellow. RGB
 LED Type:High Power
 Size:Φ177mm x H105mm
 Material:Plastic + Transparent PC cover
 IP Rate:IP68
 Beam Angle:25°/30°/45°/60°
 Packing:20PCS/Carton

GNH-P56A-20*1W

Power:21W
 Voltage:AC/DC12V
 Color:White,Red, Green, Blue, Yellow.
 LED Type:48 pc SMD5730 LED Chip
 Size:Φ177mm x H106mm
 Material:Plastic + Transparent PC cover
 IP Rate:IP68
 Beam Angle:120°
 Packing:20PCS/Carton

GNH-P56A-12*1W-H

Power:13W
 Voltage:AC/DC12V
 Color:White,Red, Green, Blue, Yellow.
 LED Type:24 pcs SMD5730 LED Chip
 Size:Φ177mm x H106mm
 Material:Plastic + Transparent PC cover
 IP Rate:IP68
 Beam Angle:120°
 Packing:20PCS/Carton

GNH-P56A-20*1W-H

Power:22W
 Voltage:AC/DC12V
 Color:White,Red, Green, Blue, Yellow
 LED Type:1 pc 20W Bridgelux COB LED
 Size:Φ177mm x H106mm
 Material:Plastic + Transparent PC cover
 IP Rate:IP68
 Beam Angle:120°
 Packing:20PCS/Carton

GNH-P56A-S5*105

Power:18W
 Voltage:AC/DC12V
 Color:White,Red, Green, Blue, Yellow. RGB
 LED Type:105 PCS * SMD5050 LED Chip
 Size:Φ177mm x H105mm
 Material:Plastic + Transparent PC cover
 IP Rate:IP68
 Beam Angle:120°
 Packing:20PCS/Carton

GNH-P56A-S3*315

Power:18W
 Voltage:AC/DC12V
 Color:White,Red, Green, Blue, Yellow. RGB
 LED Type:315 PCS * SMD3528 LED chip
 Size:Φ177mm x H105mm
 Material:Plastic + Transparent PC cover
 IP Rate:IP68
 Beam Angle:120°
 Packing:20PCS/Carton

GNH-P56A-S3*252

Power:15W
 Voltage:AC/DC12V
 Color:White,Red, Green, Blue, Yellow. RGB
 LED Type:252 PCS * SMD3528 LED Chip
 Size:Φ177mm x H105mm
 Material:Plastic + Transparent PC cover
 IP Rate:IP68
 Beam Angle:120°
 Packing:20PCS/Carton

**GNH--P56M-20*1W-V1
(SMD5730)**

Power:21W
 Voltage:AC/DC12V
 Color: White, Green, Blue, Red, Yellow
 LED Type:48 PCS * SMD5730 LED Chip
 Size:Φ290mm x H150.60mm
 Material:ABS + Transparent PC cover(lens)
 IP Rate:IP68
 Beam Angle:120°
 Packing:10PCS/Carton

**GNH-P56M-12*1W-V1
(SMD5730)**

Power:12W
 Voltage:AC/DC12V
 Color: White,Red, Green, Blue, Yellow.
 LED Type:24 PCS * SMD5730 LED Chip
 Size:Φ290mm x H150.60mm
 Material:ABS + Transparent PC cover(lens)
 IP Rate:IP68
 Beam Angle:120°
 Packing:10PCS/Carton

**GNH-P56M-12*1W-V1
(SMD5050)**

Power:13±1W(W/G/B)/ 12±1W(RGB)/ 9±1W(Red)
 Voltage:AC/DC12V
 Color: White,Red, Green, Blue, Yellow. RGB
 LED Type:72PCS * SMD5050 LED Chip
 Size:Φ290mm x H150.60mm
 Material:ABS + Transparent PC cover(lens)
 IP Rate:IP68
 Beam Angle:120°
 Packing:10PCS/Carton

GNH-P56B-18*3W-V1 (RGB 3 IN 1 LED)

Power:25 W
 Voltage:AC/DC12V
 Color: White,Red, Green, Blue, Yellow. RGB
 LED Type:High Power
 Size:Φ290mm x H150.60mm
 Material:ABS + Transparent PC cover(lens)
 IP Rate:IP68
 Beam Angle:15° /25° /30° /45° /60°
 Packing:10PCS/Carton

GNH-P56B-P56M-18*1W-V1

Power:19±1W(W/G/B)/ 18±1W(RGB)/ 14±1W(Red)
 Voltage:AC/DC12V
 Color: White,Red, Green, Blue, Yellow. RGB
 LED Type:High Power
 Size:Φ290mm x H150.60mm
 Material:ABS + Transparent PC cover(lens)
 IP Rate:IP68
 Beam Angle:15° /25° /30° /45° /60°
 Packing:10PCS/Carton

GNH-P56M-105S5-V1

Power:18±1W(W/G/B)/ 17±1WRGB)/ 14±1W(Red)
 Voltage:AC/DC12V
 Color: White,Red, Green, Blue, Yellow. RGB
 LED Type:105PCS 5050SMD
 Size:Φ290mm x H150.60mm
 Material:ABS + Transparent PC cover(lens)
 IP Rate:IP68
 Beam Angle:120°
 Packing:10PCS/Carton

GNH-P56M-252D5-V1

Power:15±1W(W/G/B)/ 14±1WRGB)/ 11±1W(Red)
 Voltage:AC/DC12V
 Color: White,Red, Green, Blue, Yellow. RGB
 LED Type:252PCS * SMD3528
 Size:Φ290mm x H150.60mm
 Material:ABS + Transparent PC cover(lens)
 IP Rate:IP68
 Beam Angle:120°
 Packing:10PCS/Carton

GNH-P56M-315D5-V1

Power:18±1W(W/G/B)/ 17±1W(RGB)/ 13±1W(Red)
 Voltage:AC/DC12V
 Color: White,Red, Green, Blue, Yellow. RGB
 LED Type:315PCS * SMD3528/DIP F5 LED Chip
 Size:Φ290mm x H150.60mm
 Material:ABS + Transparent PC cover(lens)
 IP Rate:IP68
 Beam Angle:120°
 Packing:10PCS/Carton

GNH-WM-105S5-15W-I

Power:15W
 Voltage:AC/DC12V
 Color: RGB
 LED Type:105PCS * 5050SMD
 Size:Φ295mm x H65mm
 Material:ABS + Transparent PC cover(lens)
 IP Rate:IP68
 Beam Angle:120°
 Packing:10PCS/Carton

GNH-WM-252S5-15W-J

Power:15W
 Voltage:AC/DC12V
 Color: White,Red, Green, Blue, Yellow. RGB
 LED Type:252PCS * SMD3528
 Size:Φ290mm x H170mm
 Material:ABS + Transparent PC cover(lens)
 IP Rate:IP68
 Beam Angle:120°
 Packing:10PCS/Carton

GNH-WM-315S5-18W-K

Power:18W
 Voltage:AC/DC12V
 Color: White,Red, Green, Blue, Yellow. RGB
 LED Type:315PCS * SMD3528
 Size:Φ290mm x H170mm
 Material:ABS + Transparent PC cover(lens)
 IP Rate:IP68
 Beam Angle:120°
 Packing:10PCS/Carton

**GNH-WM-252P-18W-A
GNH-WM-441P-35W-A**

Power:18W/35W
 Voltage:AC/DC12V
 Color: White, Green, Blue, Red, Yellow,RGB
 LED Type:DIP
 Size:Φ240mm x H42mm
 Material:PC
 IP Rate:IP68
 Beam Angle:120°
 Packing:10PCS/Carton

**GNH-WM-96P-7W-B
GNH-WM-144P-10W-B
GNH-WM-252P-18W-B**

Power:7W/10W/18W
 Voltage:AC/DC12V
 Color: White,Red, Green, Blue, Yellow. RGB
 LED Type:DIP
 Size:Φ180mm x H40mm
 Material:PC
 IP Rate:IP68
 Beam Angle:120°
 Packing:10PCS/Carton

**GNH-WM-9X1W-S-C/GNH-WM-12X1W-S-C
GNH-WM-18X1W-S-C/GNH-WM-24X1W-S-C
GNH-WM-18X3W-S-C**

Power:9W/12W/18W/24W/54W
 Voltage:AC/DC12V
 Color: White,Red, Green, Blue, Yellow. RGB
 LED Type:High Power
 Size:Φ300mm x H60mm
 Material:Stainless Steel304+PC
 IP Rate:IP68
 Beam Angle:25°/30°/45°/60°
 Packing:10PCS/Carton

**GNH-WM-6X1W-S-D/GNH-WM-9X1W-S-D
GNH-WM-12X1W-S-D/GNH-WM-9X3W-S-D
GNH-WM-12X3W-S-D**

Power:6W/9W/12W/27W/36W
 Voltage:AC/DC12V
 Color: White,Red, Green, Blue, Yellow. RGB
 LED Type:High Power
 Size:Φ230mm x H45mm
 Material:Stainless Steel304+PC
 IP Rate:IP68
 Beam Angle:25°/30°/45°/60°
 Packing:10PCS/Carton

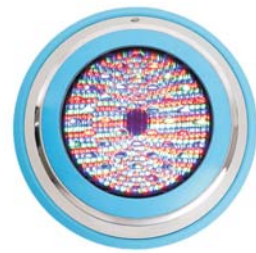

GNH-WM-144S-10W-E/GNH-WM-252S-18W-E
GNH-WM-324S-24W-E/GNH-WM-513S-38W-E

Power:10W/18W/24W/38W
 Voltage:AC/DC12V
 Color: White,Red, Green, Blue, Yellow. RGB
 LED Type:DIP
 Size:Φ300mm x H70mm
 Material:Stainless Steel304+PC
 IP Rate:IP68
 Beam Angle:120°
 Packing:10PCS/Carton

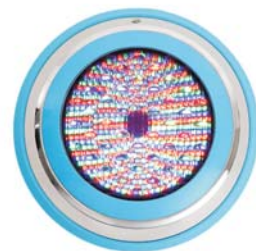

GNH-WM-96S-7W-F
GNH-WM-144S-10W-F
GNH-WM-252S-18W-F

Power:7W/10W/18W
 Voltage:AC/DC12V
 Color: White,Red, Green, Blue, Yellow. RGB
 LED Type:DIP
 Size:Φ230mm x H48mm
 Material:Stainless Steel304+PC
 IP Rate:IP68
 Beam Angle:120°
 Packing:10PCS/Carton



GNH-WM-144P-10W-G
GNH-WM-252P-18W-G
GNH-WM-513P-38W-G

Power:10W/18W/38W
 Voltage:AC/DC12V
 Color: White,Red, Green, Blue, Yellow. RGB
 LED Type:DIP
 Size:Φ295mm x H70mm
 Material:PC
 IP Rate:IP68
 Beam Angle:120°
 Packing:10PCS/Carton



GNH-WM-9X1W-P-H
GNH-WM-12X1W-P-H
GNH-WM-18X1W-P-H

Power:9W/12W/18W
 Voltage:AC/DC12V
 Color: White,Red, Green, Blue, Yellow. RGB
 LED Type:High Power
 Size:Φ295mm x H70mm
 Material:PC
 IP Rate:IP68
 Beam Angle:120°
 Packing:10PCS/Carton

Led Vinyl Pool Light

LED Vinyl Pool Light

- Ground Lighting
- Pool Bulbs
- Underwater Pool
- Floating Lights

Applications

Vinyl Pool
 Garden Pond
 Square
 Water cloumn
 Flower-bed in villas
 Garden, rocky water-fall
 Outdoor fountain, etc.

GNH-P20-3X1W-A

Power:3W
 Voltage:AC/DC12V
 Color: White,Red, Green, Blue, Yellow.
 LED Type:3PCS*High Power LED
 Size:Φ95×90 mm
 Material:ABS + Transparent PC cover(lens)
 IP Rate:IP68
 Beam Angle:15° /25° /30° /45° /60°
 Packing:30PCS/Carton

GNH-P20-3X1W-B

Power:3W
 Voltage:AC/DC12V
 Color: White,Red, Green, Blue, Yellow.
 LED Type:3PCS*High Power LED
 Size:Φ95×90 mm
 Material:ABS + Transparent PC cover(lens)
 IP Rate:IP68
 Beam Angle:15° /25° /30° /45° /60°
 Packing:30PCS/Carton

GNH-P20-3X1W-C

Power:3W
 Voltage:AC/DC12V
 Color: White,Red, Green, Blue, Yellow.
 LED Type:3PCS*High Power LED
 Size:Φ95×90 mm
 Material:ABS + Transparent PC cover(lens)
 IP Rate:IP68
 Beam Angle:15° /25° /30° /45° /60°
 Packing:30PCS/Carton

GNH-P56B-18*3W-V2 (RGB 3 IN 1 LED)

Power:25 W
 Voltage:AC/DC12V
 Color: White,Red, Green, Blue, Yellow. RGB
 LED Type:High Power
 Size:Φ290mm x H150.60mm
 Material:ABS + Transparent PC cover(lens)
 IP Rate:IP68
 Beam Angle:15° /25° /30° /45° /60°
 Packing:10PCS/Carton

GNH-P56B-P56M-18*1W-V2

Power:19±1W(W/G/B)/ 18±1W(RGB)/ 14±1W(Red)
 Voltage:AC/DC12V
 Color: White,Red, Green, Blue, Yellow. RGB
 LED Type:High Power
 Size:Φ290mm x H150.60mm
 Material:ABS + Transparent PC cover(lens)
 IP Rate:IP68
 Beam Angle:15° /25° /30° /45° /60°
 Packing:10PCS/Carton

GNH-P56M-315D5-V2

Power:18±1W(W/G/B)/ 17±1WRGB/ 13±1W(Red)
 Voltage:AC/DC12V
 Color: White,Red, Green, Blue, Yellow. RGB
 LED Type:315PCS * SMD3528/DIP F5 LED Chip
 Size:Φ290mm x H150.60mm
 Material:ABS + Transparent PC cover(lens)
 IP Rate:IP68
 Beam Angle:120°
 Packing:10PCS/Carton

GNH--P56M-20*1W-V2 (SMD5730)

Power:21W
 Voltage:AC/DC12V
 Color: White,Red, Green, Blue, Yellow.
 LED Type:48 PCS * SMD5730 LED Chip
 Size:Φ290mm x H150.60mm
 Material:ABS + Transparent PC cover(lens)
 IP Rate:IP68
 Beam Angle:120°
 Packing:10PCS/Carton

GNH-P56M-12*1W-V2 (SMD5730)

Power:12W
 Voltage:AC/DC12V
 Color: White,Red, Green, Blue, Yellow.
 LED Type:24 PCS * SMD5730 LED Chip
 Size:Φ290mm x H150.60mm
 Material:ABS + Transparent PC cover(lens)
 IP Rate:IP68
 Beam Angle:120°
 Packing:10PCS/Carton

**GNH-P56M-12*1W-V2
(SMD5050)**

Power:13±1W(W/G/B)/ 12±1W(RGB)/ 9±1W(Red)
 Voltage:AC/DC12V
 Color: White,Red, Green, Blue, Yellow. RGB
 LED Type: 72PCS * SMD5050 LED Chip
 Size:Φ290mm x H150.60mm
 Material:ABS + Transparent PC cover(lens)
 IP Rate:IP68
 Beam Angle:120°
 Packing:10PCS/Carton

GNH-P56M-105S5-V2

Power:18±1W(W/G/B)/ 17±1W(RGB)/ 14±1W(Red)
 Voltage:AC/DC12V
 Color: White,Red, Green, Blue, Yellow. RGB
 LED Type:105PCS 5050SMD
 Size:Φ290mm x H150.60mm
 Material:ABS + Transparent PC cover(lens)
 IP Rate:IP68
 Beam Angle:120°
 Packing:10PCS/Carton

GNH-P56M-252D5-V2

Power:15±1W(W/G/B)/ 14±1W(RGB)/ 11±1W(Red)
 Voltage:AC/DC12V
 Color: White,Red, Green, Blue, Yellow. RGB
 LED Type:252PCS * SMD3528
 Size:Φ290mm x H150.60mm
 Material:ABS + Transparent PC cover(lens)
 IP Rate:IP68
 Beam Angle:120°
 Packing:10PCS/Carton

LED Fountain Light LED Underwater Light



LED Underwater Light LED Fountain Light

- High Power LED Fountain Light
- RGB LED Fountain Light
- High Power LED Underwater Light
- RGB LED Underwater Light

Applications

The Fountain Light and the Pond light are widely used in Fountains, Swimming Pools, Ponds & Gardens. Ideal for architectural or event illumination.

GNH-UW-12*3W

Power:18W
 Voltage:12V AC/DC 50~60Hz
 Color: RGB
 LED Type:12 pcs * 1W LED chip
 Size:Φ179mm x H77mm
 Material:aluminium + transparent PC cover
 IP Rate:IP68
 Beam Angle:25° /30°/45°/60°
 Packing:30PCS/Carton

GNH-UW-9*1W-A

Power:9W
 Voltage:12V AC/DC 50~60Hz
 Color:White,Red, Green, Blue, Yellow. RGB
 LED Type:9 pcs * 1W LED Chip
 Size:Φ160mm x H60mm
 Material:aluminium + transparent PC cover
 IP Rate:IP68
 Beam Angle:25° /30°/45°/60°
 Packing:30PCS/Carton

GNH-UW-9*3W-A

Power:27W
 Voltage:12V AC/DC 50~60Hz
 Color:White,Red, Green, Blue, Yellow. RGB
 LED Type: 9 pcs * 3W LED Chip
 Size:Φ160mm x H60mm
 Material:aluminium + transparent PC cover
 IP Rate:IP68
 Beam Angle:25° /30°/45°/60°
 Packing:30PCS/Carton

GNH-UW-12*1W-B

Power:36W
 Voltage:12V AC/DC 50~60Hz
 Color:White,Red, Green, Blue, Yellow.RGB
 LED Type: 12pcs * 1W LED Chip
 Size:Φ180mm x H80mm
 Material: aluminium + transparent PC cover
 IP Rate:IP68
 Beam Angle:25° /30°/45°/60°
 Packing:30PCS/Carton

GNH-UW-12*3W-B

Power:36W
 Voltage:12V AC/DC 50~60Hz
 Color:White,Red, Green, Blue, Yellow. RGB
 LED Type:12 pcs * 3W LED chip
 Size:Φ180mm x H80mm
 Material:aluminium + transparent PC cover
 IP Rate:IP68
 Beam Angle:25° /30°/45°/60°
 Packing:30PCS/Carton

GNH-UW-9*1W

Power:9W
 Voltage:12V AC/DC 50~60Hz
 Color:White,Red, Green, Blue, Yellow. RGB
 LED Type:9 pcs * 1W LED Chip
 Size:Φ179mm x H77mm
 Material:316 Stainless Steel + Transparent PC cover
 IP Rate:IP68
 Beam Angle:25° /30°/45°/60°
 Packing:20PCS/Carton

GNH-UW-9*3W

Power:15W
 Voltage:12V AC/DC 50~60Hz
 Color:RGB
 LED Type: 9 pcs * 3W LED Chip
 Size:Φ179mm x H77mm
 Material:316 Stainless Steel + Transparent PC cover
 IP Rate:IP68
 Beam Angle:25° /30°/45°/60°
 Packing:20PCS/Carton

GNH-UW-12*1W

Power:12W
 Voltage:12V AC/DC 50~60Hz
 Color:White,Red, Green, Blue, Yellow.RGB
 LED Type: 12pcs * 1W LED Chip
 Size:Φ179mm x H77mm
 Material: aluminium + transparent PC cover
 IP Rate:IP68
 Beam Angle:25° /30°/45°/60°
 Packing:30PCS/Carton



GNH-UW-1W-C
GNH-UW-3W-C

Power:1W/3W
Voltage:AC/DC12V/24V 50-60Hz
Color: white, yellow,red, green, blue, RGB
LED Type: 1 pcs * 1W LED chip
Size:Φ60mm x H70mm
Material:316 Stainless steel + transparent PC cover
IP Rate:IP68
Beam Angle:10° /25°/30°/45°/60°/90°
Packing:4PCS/Carton

GNH-UW-3W-D



Power:3W
Voltage:AC/DC12V/24V 50-60Hz
Color: white, yellow,red, green, blue, RGB
LED Type: 3 pcs * 1W LED chip
Size:Φ82mm x H120mm
Material:316 Stainless steel + transparent PC cover
IP Rate:IP68
Beam Angle:10° /25°/30°/45°/60°/90°
Packing:4PCS/Carton

GNH-UW-3W-E



Power:3W
Voltage:AC/DC12V/24V 50-60Hz
Color: white, yellow,red, green, blue, RGB
LED Type: 3 pcs * 1W LED chip
Size:Φ85mm x H105mm
Material:304 Stainless steel + transparent PC cover
IP Rate:IP68
Beam Angle:10° /25°/30°/45°/60°/90°
Packing:4PCS/Carton

GNH-UW-3X3W-F



Power:9W
Voltage:AC/DC12V/24V 50-60Hz
Color: white, yellow,red, green, blue, RGB
LED Type: 3 pcs * 1W LED chip
Size:Φ100mm x H140mm
Material:304 Stainless steel + transparent PC cover
IP Rate:IP68
Beam Angle:10° /25°/30°/45°/60°/90°
Packing:4PCS/Carton



GNH-UW-6*1W-G

Power: 6W
Voltage:AC/DC12V/24V 50-60Hz
Color: white, yellow,red, green, blue, RGB
LED Type: 6 pcs * 1W LED chip
Size:Φ120mm x H145mm
Material:304 Stainless steel + transparent PC cover
IP Rate:IP68
Beam Angle:10° /25°/30°/45°/60°/90°
Packing:4PCS/Carton

GNH-UW-9*1W-H



Power:9W
Voltage:AC/DC12V/24V 50-60Hz
Color: white, yellow,red, green, blue, RGB
LED Type: 9 pcs * 1W LED chip
Size:Φ145mm x H165mm
Material:304 Stainless steel + transparent PC cover
IP Rate:IP68
Beam Angle:10° /25°/30°/45°/60°/90°
Packing:4PCS/Carton

GNH-UW-12*1W-I



Power:12W
Voltage:AC/DC12V/24V 50-60Hz
Color: white, yellow,red, green, blue, RGB
LED Type: 12 pcs * 1W LED chip
Size:Φ160mm x H210mm
Material:304 Stainless steel + transparent PC cover
IP Rate:IP68
Beam Angle:10° /25°/30°/45°/60°/90°
Packing:4PCS/Carton

GNH-UW-18*1W-J



Power:18W
Voltage:AC/DC12V/24V 50-60Hz
Color: white, yellow,red, green, blue, RGB
LED Type: 12 pcs * 1W LED chip
Size:Φ180mm x H220mm
Material:304 Stainless steel + transparent PC cover
IP Rate:IP68
Beam Angle:10° /25°/30°/45°/60°/90°
Packing:4PCS/Carton

LED Inground Light



LED Inground Light

- High Power LED Inground Light
- SMD3528 LED Inground Light
- SMD3350 LED Inground Light
- SMD5050 LED Inground Light
- RGB LED Inground Light

Applications

Buildings, indoor, stairs, corridors,
Meeting rooms, showrooms
Shopping malls
Hotels and other places for
decoration and lighting as well

GNH-IG-0.24W-A



Power:0.24W
Voltage:12V DC
Color: Red/ Green/ Blue/Yellow/ WW/ CW
LED Type:SMD3528
Size:Φ26*H41mm
Material:aluminium
IP Rate:IP65
Packing:100PCS/Carton

GNH-IG-0.24W-B



Power:0.24W
Voltage:12V DC
Color: Red/ Green/ Blue/Yellow/ WW/ CW
LED Type:SMD3528
Size:Φ26*H38.50mm
Material:aluminium
IP Rate:IP67
Packing:100PCS/Carton

GNH-IG-0.24W-C



Power:0.24W
Voltage:12V DC
Color: Red/ Green/ Blue/Yellow/ WW/ CW
LED Type:SMD3528
Size:Φ28*H28mm
Material:PC&Stainless Steel
IP Rate:IP67
Packing:100PCS/Carton

GNH-IG-0.6W-C



Power:0.6W
Voltage:12V DC
Color: RGB
LED Type:SMD5050
Size:Φ28*H28mm
Material:PC&Stainless Steel
IP Rate:IP67
Packing:100PCS/Carton

**GNH-IG-0.36W-D**

Power:0.36W
 Voltage:12V DC
 Color: Red/ Green/ Blue/Yellow/ WW/ CW
 LED Type:SMD3350
 Size:Φ28*H28mm
 Material:PC&Stainless Steel
 IP Rate:IP67
 Packing:100PCS/Carton

**GNH-IG-0.72W-D**

Power:0.72W
 Voltage:12V DC
 Color: RGB
 LED Type:SMD3350
 Size:Φ28*H28mm
 Material:PC&Stainless Steel
 IP Rate:IP67
 Packing:100PCS/Carton

**GNH-IG-0.6W-E**

Power:0.6W
 Voltage:12V DC
 Color: Red/ Green/ Blue/Yellow/ WW/ CW
 LED Type:SMD3350
 Size:W58.5*L58.5*H28mm
 Material:PC&Stainless Steel
 IP Rate:IP67
 Packing:100PCS/Carton

**GNH-IG-1.32W-E**

Power:1.32W
 Voltage:12V DC
 Color: RGB
 LED Type:SMD3350
 Size:W58.5*L58.5*H28mm
 Material:PC&Stainless Steel
 IP Rate:IP67
 Packing:100PCS/Carton

**GNH-IG-1W-F**

Power:1W
 Voltage:12V DC
 Color: Red/ Green/ Blue/Yellow/ WW/ CW
 LED Type:High Power
 Size:Φ42*H58mm
 Material:aluminium
 IP Rate:IP65
 Packing:100PCS/Carton

**GNH-IG-1W-F**

Power:1W
 Voltage:12V DC
 Color: RGB
 LED Type:High Power
 Size:Φ42*H58mm
 Material:aluminium
 IP Rate:IP67
 Packing:100PCS/Carton

**GNH-IG-1W-G**

Power:1W
 Voltage:12V DC
 Color: Red/ Green/ Blue/Yellow/ WW/ CW
 LED Type:High Power
 Size:W45*L45*H58mm
 Material:aluminium
 IP Rate:IP67
 Packing:100PCS/Carton

**GNH-IG-1W-G**

Power:1W
 Voltage:12V DC
 Color: RGB
 LED Type:High Power
 Size:W45*L45*H58mm
 Material:aluminium
 IP Rate:IP67
 Packing:100PCS/Carton

LED Floor Light



LED Floor Light

- High Power LED Floor Light
- SMD3350 LED Floor Light
- SMD3350 LED Inground Light
- SMD5050 LED Floor Light
- RGB LED Floor Light

Applications

Buildings, indoor, stairs, corridors,
Meeting rooms, showrooms
Shopping malls
Hotels and other places for
decoration and lighting as well

GNH-FD-0.5W-A



Power:0.5W
Voltage:12V DC
Color: Red/ Green/ Blue/Yellow/ WW/ CW
LED Type:SMD3350
Size:Φ58*H9mm
Material:Stainless steel
IP Rate:IP54/IP67
Packing:100PCS/Carton

GNH-FD-0.7W-A



Power:0.7W
Voltage:12V DC
Color: RGB
LED Type:SMD3350
Size:Φ58*H9mm
Material:Stainless steel
IP Rate:IP54/IP67
Packing:100PCS/Carton

GNH-FD-0.6W-B GNH-FD-0.9W-B



Power:0.6W/0.9W
Voltage:12V DC
Color: Red/ Green/ Blue/Yellow/ WW/ CW/RGB
LED Type:SMD3350
Size:L58*W58*H9mm
Material:Stainless steel
IP Rate:IP54/IP67
Packing:100PCS/Carton

GNH-FD-0.4W-C



Power:0.4W
Voltage:12V DC
Color: Red/ Green/ Blue/Yellow/ WW/ CW
LED Type:SMD3350
Size:Φ58*H9mm
Material:Stainless steel
IP Rate:IP54/IP67
Packing:100PCS/Carton

**GNH-FD-0.4W-D**

Power:0.4W
 Voltage:12V DC
 Color: Red/ Green/ Blue/Yellow/ WW/ CW/RGB
 LED Type:SMD5050
 Size:Φ39. 5*H19. 4mm
 Material:Stainless steel
 IP Rate:IP67
 Packing:100PCS/Carton

**GNH-FD-0.3W-E**

Power:0.3W
 Voltage:12V DC
 Color: Red/ Green/ Blue/Yellow/ WW/ CW/RGB
 LED Type:SMD2835
 Size:Φ30*H18. 5mm
 Material:Stainless steel
 IP Rate:IP54/IP67
 Packing:100PCS/Carton

**GNH-FD-0.23W-F**

Power:0.23W
 Voltage:12V DC
 Color: Red/ Green/ Blue/Yellow/ WW/ CW/RGB
 LED Type:SMD5050
 Size:Φ30*H18. 5mm
 Material:Zinc Alloy
 IP Rate:IP65
 Packing:100PCS/Carton

LED Garden Light LED Flood Light



LED Garden Light

- High Power LED Garden Light
- RGB LED Garden Light
- Spike LED Garden Light

LED Flood Light

- RGB LED Flood Light
- COB LED Flood Light
- Color Changing LED Flood Light

Applications

Advertising signs and other fine decorative indoor/outdoor. Middle and top grade stores, shopping malls and other indoor commercial lighting atmosphere. Building outline, glass curtain wall lighting. Garden or street for spot or decoration.

**GNH-GL-3X1W-A**

Power:3W
 Voltage:DC24V 50~60Hz
 Color: Red/ Green/ Blue/Yellow/White/RGB
 LED Type:3pcs *High Power
 Size:D68XH56XH155
 Material: 6063 Aluminum
 IP Rate:IP65
 Beam Angle:15° /25°/45° /60°

**GNH-GL-6X1W-B**

Power:6W
 Voltage:DC24V 50~60Hz
 Color: Red/ Green/ Blue/Yellow/White
 LED Type:6pcs *High Power
 Size:D92XH180
 Material: 6063 Aluminum
 IP Rate:IP65
 Beam Angle:15° /25°/45° /60°

**GNH-GL-9X1W-C**

Power:9W
 Voltage:DC24V 50~60Hz
 Color: Red/ Green/ Blue/Yellow/White
 LED Type:9pcs *High Power
 Size: D117XH155
 Material: 6063 Aluminum
 IP Rate:IP65
 Beam Angle:15° /25°/45° /60°

**GNH-GL-12X1W-D**

Power:12W
 Voltage:DC24V 50~60Hz
 Color: Red/ Green/ Blue/Yellow/White
 LED Type:12pcs *High Power
 Size:D117XH155
 Material: 6063 Aluminum
 IP Rate:IP65
 Beam Angle:15° /25°/45° /60°

**GNH-GL-18X1W-E**

Power:18W
 Voltage:DC24V 50~60Hz
 Color: Red/ Green/ Blue/Yellow/White
 LED Type:18pcs *High Power
 Size:D150XH200
 Material: 6063 Aluminum
 IP Rate:IP65
 Beam Angle:15° /25°/45° /60°

**GNH-FL-MN01-10W-H01**

Power:1*10W
 Voltage:AC 100-240V/DC24V
 Color: Red/ Green/ Blue/Yellow/ WW/ CW,RGB
 LED Type: Epistar /CREE/Bridgelux
 Size:115X85X85mm
 Material:Aluminum
 IP Rate:IP65
 Beam Angle:90°

**GNH-FL-MN01-20W-H01**

Power:1*20W
 Voltage:AC 100-240V/DC24V
 Color: Red/ Green/ Blue/Yellow/ WW/ CW,RGB
 LED Type: Epistar /CREE/Bridgelux
 Size:180x140x110mm
 Material:Aluminum
 IP Rate:IP65
 Beam Angle:90°

**GNH-FL-MN01-30W-H01**

Power:1*30W
 Voltage:AC 100-240V/DC24V
 Color: Red/ Green/ Blue/Yellow/ WW/ CW,RGB
 LED Type: Epistar /CREE/Bridgelux
 Size:225X185X125mm
 Material:Aluminum
 IP Rate:IP65
 Beam Angle:90°

GNH-FL-MN01-50W-H01

Power:1*50W
 Voltage:AC100-240V/DC24V
 Color: Red/ Green/ Blue/Yellow/ WW/ CW,RGB
 LED Type: Epistar /CREE/Bridgelux
 Size:288X238X160mm
 Material:Aluminum
 IP Rate:IP65
 Beam Angle:90°

GNH-FL-MN02-80W-H01

Power:1*80W
 Voltage:AC100-240V/DC24V
 Color: Red/ Green/ Blue/Yellow/ WW/ CW,RGB
 LED Type: Epistar /CREE/Bridgelux
 Size:360X285X130mm
 Material:Aluminum
 IP Rate:IP65
 Beam Angle:90°

GNH-FL-MN02-100W-H01

Power:1*100W
 Voltage:AC100-240V/DC24V
 Color: Red/ Green/ Blue/Yellow/ WW/ CW,RGB
 LED Type: Epistar /CREE/Bridgelux
 Size:360X285X130mm
 Material:Aluminum
 IP Rate:IP65
 Beam Angle:90°

GNH-FL-MN02-120W-H01

Power:1*120W
 Voltage:AC100-240V/DC24V
 Color: Red/ Green/ Blue/Yellow/ WW/ CW,RGB
 LED Type: Epistar /CREE/Bridgelux
 Size:335X235X130mm
 Material:Aluminum
 IP Rate:IP65
 Beam Angle:90°

LED Strip Light

RGB LED Pool Light



LED Strip Light

- DMX Flexible LED Strip Light
- WIFI Flexible LED Strip Light
- Color Changing RGB LED Strip Light

Applications

Outdoor Light, Garden, Swimming Pool, Landscape, Shopping mall, advertisement area.

GNH5050-6803-30LED-12V

Power:7.2W
Voltage:12V DC
Color: FULL COLOR
LED Type:5050SMD RGB
Size:5000*12*2.4mm
IC Type:LPD6803
IP Rate:IP20/IP67
Packing:5 M/Roll, 3 leds/cut

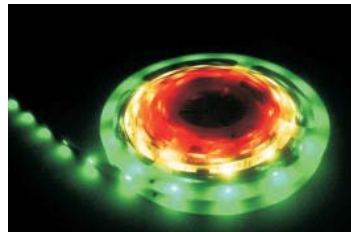
GNH5050-1809-30LED-12V

Power:7.2W
Voltage:12V DC
Color: FULL COLOR
LED Type:5050SMD RGB
Size:5000*12*2.4mm
IC Type:TM1809
IP Rate:IP20/IP67
Packing:5 M/Roll, 3 leds/cut

GNH5050-2811-30LED-12V

Power:7.2W
Voltage:12V DC
Color: FULL COLOR
LED Type:5050SMD RGB
Size:5000*10*2.4mm
IC Type:WS2811
IP Rate:IP20/IP67
Packing:5 M/Roll, 3 leds/cut

GNH5050-2812B-30LED-5V(IC BUILD IN)

Power:9W
Voltage:5V DC
Color: FULL COLOR
LED Type:5050SMD RGB
Size:5000*12*2.4mm
IC Type:WS2812B
IP Rate:IP20/IP67
Packing:5 M/Roll, 3 leds/cut

GNH5050-2812B-60LED-5V(IC BUILD IN)

Power:18W
Voltage:5V DC
Color: FULL COLOR
LED Type:5050SMD RGB
Size:4000*10*2.4mm
IC Type:WS2812B
IP Rate:IP20/IP67
Packing:4 M/Roll, 3 leds/cut

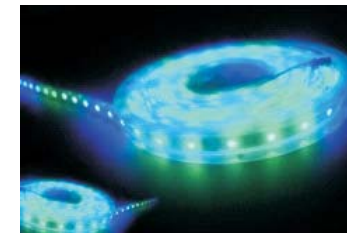
GNH5050-1003-30LED-12V

Power:7.2W
Voltage:12V DC
Color: FULL COLOR
LED Type:5050SMD RGB
Size:5000*12*2.4mm
IC Type:INK1003
IP Rate:IP20/IP67
Packing:5 M/Roll, 3 leds/cut

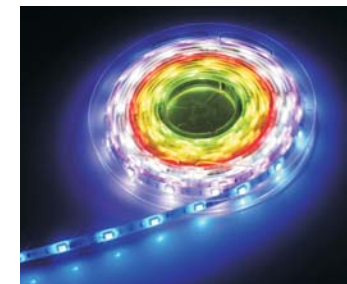
GNH5050-1003-60LED-12V

Power:14.4W
Voltage:12V DC
Color: FULL COLOR
LED Type:5050SMD RGB
Size:5000*12*2.4mm
IC Type:INK1003
IP Rate:IP20/IP67
Packing:5 M/Roll, 3 leds/cut

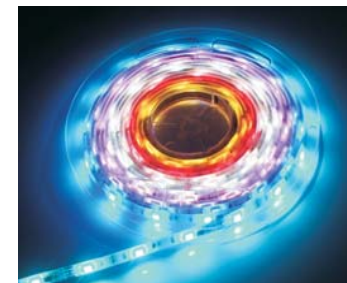
GNH5050-1003-48LED-12V

Power:12W
Voltage:12V DC
Color: FULL COLOR
LED Type:5050SMD RGB
Size:5000*10*2.4mm
IC Type:INK1003
IP Rate:IP20/IP67
Packing:5 M/Roll, 3 leds/cut

GNH5050-1003-60LED-12V

Power:14.4W
Voltage:12V DC
Color: FULL COLOR
LED Type:5050SMD RGB
Size:5000*10*2.4mm
IC Type:INK1003
IP Rate:IP20/IP67
Packing:5 M/Roll, 3 leds/cut

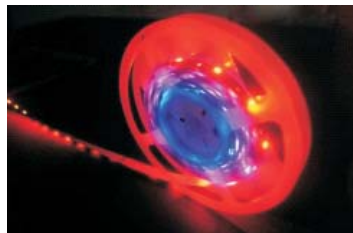
GNH5050-1812-32LED-12V

Power:7.68W
Voltage:12V DC
Color: FULL COLOR
LED Type:5050SMD RGB
Size:5000*12*2.4mm
IC Type:TM1812
IP Rate:IP20/IP67
Packing:5 M/Roll, 3 leds/cut

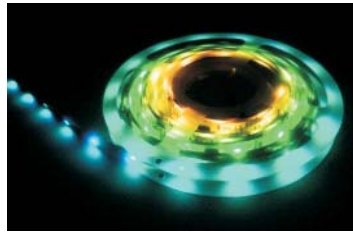
GNH5050-1812-60LED-12V

Power:14.4W
Voltage:12V DC
Color: FULL COLOR
LED Type:5050SMD RGB
Size:5000*12*2.4mm
IC Type:TM1812
IP Rate:IP20/IP67
Packing:5 M/Roll, 3 leds/cut

GNH5050-1812-120LED-12V

Power:28.8W
Voltage:12V DC
Color: FULL COLOR
LED Type:5050SMD RGB
Size:5000*20*2.4mm
IC Type:TM1812
IP Rate:IP20/IP67
Packing:5 M/Roll, 3 leds/cut

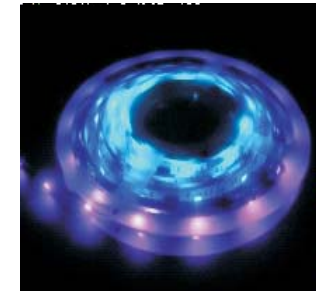
GNH5050-1812-144LED-12V

Power:34.56W
Voltage:12V DC
Color: FULL COLOR
LED Type:5050SMD RGB
Size:5000*20*2.4mm
IC Type:TM1812
IP Rate:IP20/IP67
Packing:5 M/Roll, 3 leds/cut

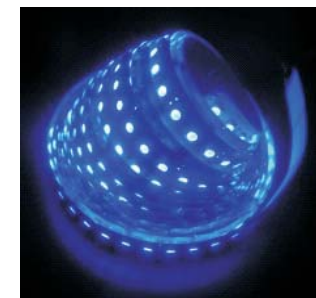
GNH5050-2801-32LED-12V

Power:9W
Voltage:12V DC
Color: FULL COLOR
LED Type:5050SMD RGB
Size:5000*12*2.4mm
IC Type:WS2801
IP Rate:IP20/IP67
Packing:5 M/Roll, 3 leds/cut

GNH5050-2801-32LED-12V

Power:9W
Voltage:12V DC
Color: FULL COLOR
LED Type:5050SMD RGB
Size:5000*12*2.4mm
IC Type:WS2801
IP Rate:IP20/IP67
Packing:5 M/Roll, 3 leds/cut

RGB Controller



RGB Controller

- RF Switch and Remote Control
- Remote controller
- External Remote control-4 wires
- DMX controller
- WIFI controller

Applications

Widely used for RGB light

RF Switch and Remote Control



Model Number: GNH-Controller-RF-A
 Input Voltage: 12-24VDC
 RF Remote Distance: 50M
 Radio Frequency: 433.92MHz

Instructions of The Remote Control Button

Key	Instruction	Key	Instruction
A	Mode change(14 programs)	C	Slow down in "fading effect" & "Dynamic color changing" mode-Reset the lamp by press 5S+decrease brightness in solid color
B	Speed up in "fading effect" & "Dynamic color changing" mode, increase brightness in solid color	D	Switch on/off by press 1-2S

Note: Remote effective distance is 50 meters, to control lamps in distance of more than 50 meters, use switch control instead of remote control. Change mode by switch on/off.

14 RGB Programs: Red; Green; Blue; R+G; G+B; R+G+B; Dynamic change; R-G; G-B; R-B; R-G-B; Colorful R-G-B Fading; Colorful fading;

Remote controller



Model Number: GNH-Controller-RE-B
 Input Voltage: 12-24VDC
 RF Remote Distance: 50M
 Radio Frequency: 433.92MHz

Remote controller Instruction

Button no.	Function	Button no.	Function
1	On/off	7	Blue
2	Reset/(RGB=white)	8	R+G/G+B/R+B
3	Speed/Brightness+	9	Dynamic change: (R-G)/(G-B)/(R-B)
4	Speed/Brightness-	10	Dynamic change: (R-G-B/Colorful Change
5	Red	11	Fading: R-G-B
6	Green	12	Colorful Fading

External Remote controller



Model Number: GNH-Controller-EX-C
 Input Voltage: 12-24VDC
 RF Remote Distance: 100M
 Radio Frequency: 433.92MHz

Detail for function Key:

8 function keys on the receiver, which is corresponding to the first 8 buttons on the RF remote: namely ON/OFF, PAUSE, MODE+, MODE-, SPEED+, SPEED-, BRT+, BRT-.

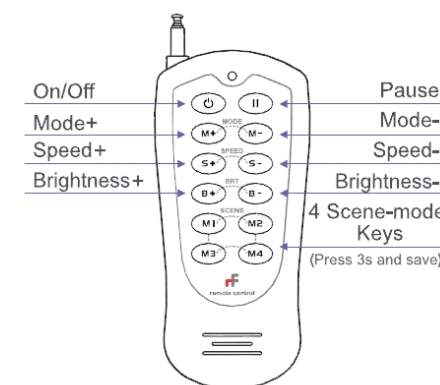
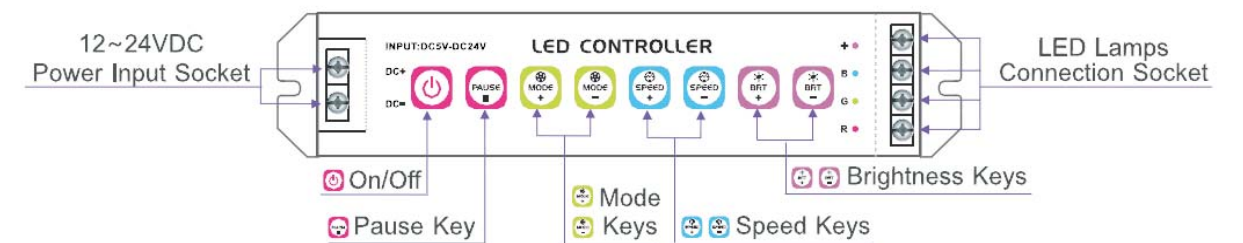

Other Functions:

- A. Press PAUSE in 3S, the buzzer can be on or off.
- B. Press MODE+ for 3S to auto loop play all the modes.
- C. Press MODE- for 3S to 4 scene modes. Merely play the changing modes, the static color will be skipped.
- D. Press SPEED+ for 3S, all speed change is restored to default status.
- E. Press SPEED- for 3S, the current change is restored to default status.

ID Learning Method:

Learning ID: Press "On/Off" key on the receiver for 3S, the buzzer long beep and the green light will be on, release the key, press any button on the remote, when the green light turns off means activated.
 Cancelling ID: Press "On/off" Key on the receiver for 5Sm the buzzer long beep, the green light will be on and flash once, meanwhile press any button on the remote, when the green light flashes several times means ID canceled (do not release the "On/Off" key during the process).

DMX controller



Model Number: GNH-Controller-DMX-D
 Input Voltage: 12-24VDC
 Output Signal: DMX512
 Output Loop: 1 Port

1. Structure Drawing

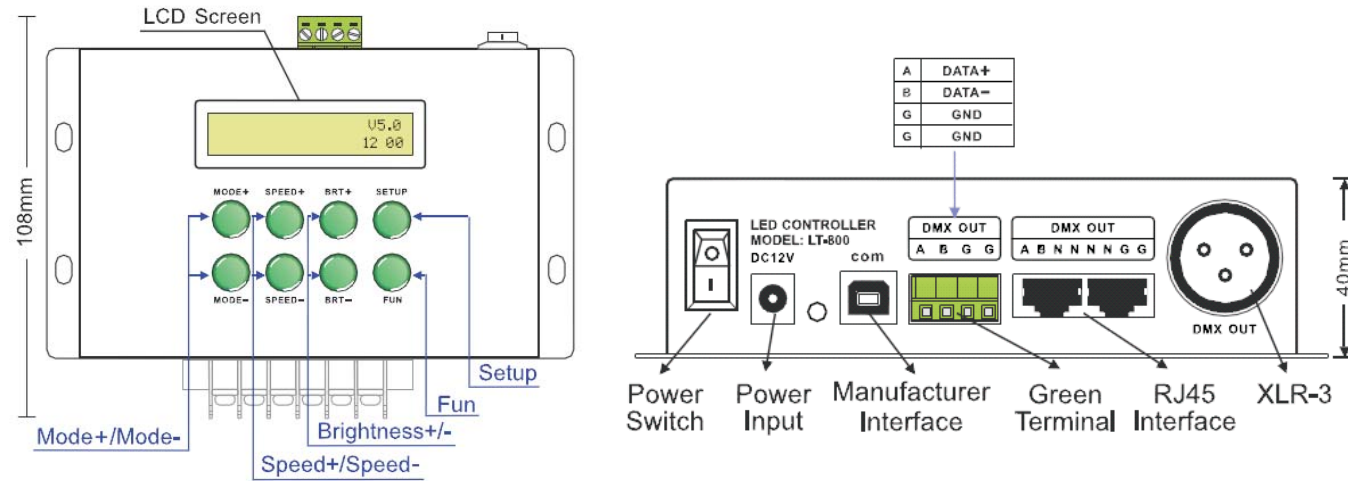

SETUP: Short press to adjust movement direction of effect; Long press to enter the menu setting interface.
 FUN: Short press to switch mode type;
 Long press to enter the DMX addressing, meanwhile start learning ID process of RF remote.

2. Controller

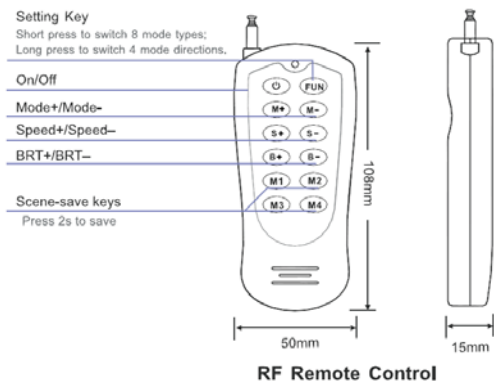

Buzzer on/off: Long press "On/Off" button on the remote.
 ID Learning Method:
 Long press button on the controller for 2 seconds, there is a buzzer beep, keep pressing:s
 Learning ID: Press any key on the remote in 3 seconds.
 Cancelling ID: Press any key on the remote over 3 seconds.

WIFI controller



Model Number: GNH-Controller-WIFI-E
 Input Voltage: 12-24VDC
 Communication Standard: 2.4GHz, 802, 11b/g/m Protocol
 WIFI Control Distance: 100M (Distance of cross-eyed)

1. Configuration Diagram

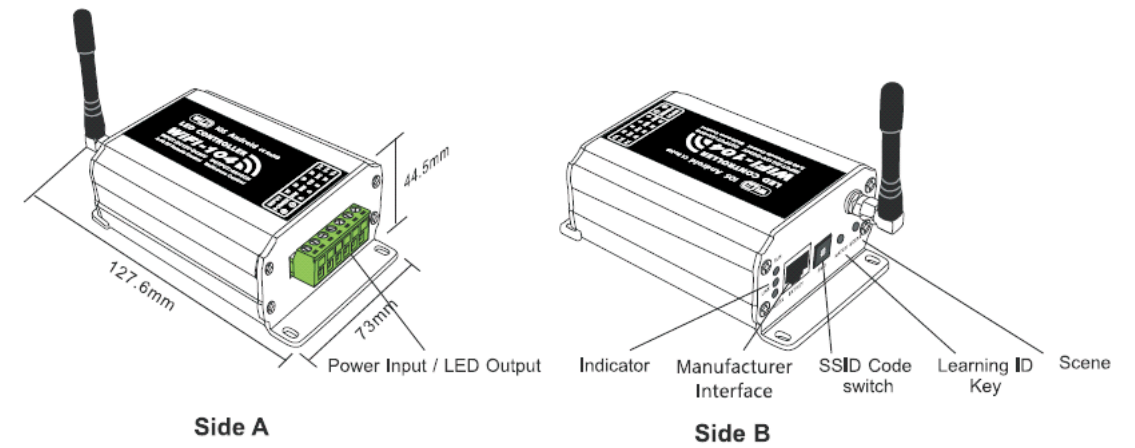

2. Controller Operating Instructions

Install/Uninstall ANT
 Clockwise to install the WIFI ANT, counter clockwise to take off.

Indicator Light Instructions:

Indicator Light	Instructions
Run	It flashes quickly about 25S during the electric initialization, Flashes once per second after initialization
Link	It keeps on when the mobile device connects to WIFI-104, and turns off when disconnected.
RX/TX	It turns on when the controller receives or transmits the WIFI data. Turns off in the free time.